

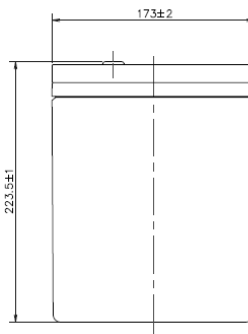

閥調式鉛酸蓄電池(VRLA)
Valve Regulated Lead Acid Battery

NPA100-12I FR

尺寸 DIMENSION

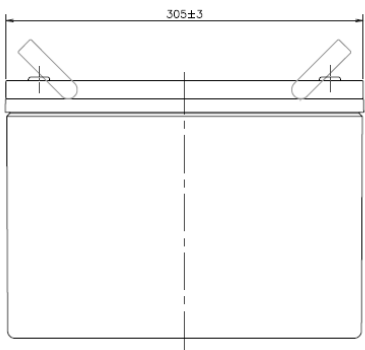
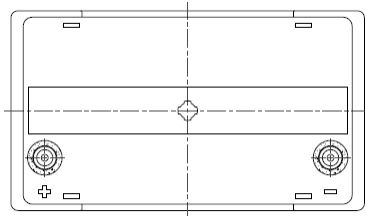

規範 Specification

<ul style="list-style-type: none"> ☞ 公稱電壓 Nominal Voltage : 12V ☞ 尺寸 Dimension <ul style="list-style-type: none"> 長度 Length : 305±3mm 寬度 Width : 173±2mm 高度 Case Height : 220±2mm 總高 Overall Height : 223.5±1mm ☞ 重量 Weight (約 Approx.) : 31.2 kg ☞ 公稱容量 Nominal Capacity : 100AH / 20HR (25°C) ☞ 內部抵抗 Internal Resistance(Approx.) : 約 3.5 mΩ ☞ 最大充電電流 Max. Charge current : 25A ☞ 最大連續放電電流 <ul style="list-style-type: none"> Max. Continuous discharge current : 300A ☞ 5 秒最大放電電流 <ul style="list-style-type: none"> Max. Discharge current in 5 seconds : 600A ☞ 浮動充電 Float Charging : 13.65±0.15V (25°C) ☞ 端子 Terminal : <ul style="list-style-type: none"> 極柱端子 Top terminal : 螺絲式 Bolt (M6) 	<ul style="list-style-type: none"> ☞ 操作溫度範圍 Operating Temperature Range <ul style="list-style-type: none"> 放電 Discharging -15°C to 45°C 充電 Charging -15°C to 45°C 放置 Storage -15°C to 45°C ☞ 期待浮充壽命 Expected float use life (25°C) : 10 years ☞ 容易保養 Easy Maintenance <ul style="list-style-type: none"> 不會洩漏電解液 No electrolyte leakage 確保操作安全性 Ensure safe and efficient operation ☞ 防爆設計 Vent plug provided with built-in ceramic filter <ul style="list-style-type: none"> 阻隔外部火源防止電池破裂 Prevent explosion from outside source of ignition ☞ 電槽材質 Container Material : <ul style="list-style-type: none"> 難燃ABS Flame Retardant ABS (FR) · 難燃等級 Flame class : UL94V0 氧氣指數 Oxygen index : 28.0% LOI ☞ 把手設計 Handle Including ☞ 用途 Applications : <ul style="list-style-type: none"> UPS 不斷電系統、電信、緊急照明、警報系統、儀器、太陽能發電系統 UPS(Uninterruptible Power Supply) · Telecommunications · Emergency lighting · Alarm systems · Instrumentation · Solar powered systems
---	--

NPA100-12IFR 性能規格 PERFORMANCE SPECIFICATION : 安培 Amperes and 瓦特 Watts at 25°C (77°F)

F.V.	TIME	5M	10M	15M	20M	30M	45M	1H	2H	3H	4H	5H	8H	10H	20H
		10.80V	W	2964	2386	1965	1652	1233	913	738	400	285	229	193	142
	A	271	210	163	133	100	74	60.6	32.9	24.1	18.8	16.1	11.2	9.35	4.91
10.50V	W	3367	2605	2058	1698	1267	930	745	403	290	230	195	143	113	59.9
	A	308	233	177	143	107	77	61.2	33.1	24.6	18.9	16.4	11.5	9.46	5.00
10.20V	W	3647	2755	2129	1738	1297	947	754	407	292	232	197	145	114	60.1
	A	324	249	187	150	111	79	61.9	33.4	24.9	19.1	16.6	11.6	9.54	5.01
10.02V	W	3708	2819	2157	1753	1308	953	756	409	292	233	197	145.6	114	60.2
	A	327	252	189	152	112	80	62.1	33.6	25.0	19.2	16.6	11.6	9.55	5.02
9.60V	W	3875	2995	2234	1791	1337	967	763	414	295	236	198	147.2	114	60.4
	A	338	261	194	155	114	81	62.7	34.0	25.4	19.4	16.7	11.7	9.60	5.04

特性 Characteristics

放電特性 DISCHARGE CHARACTERISTICS

放電曲線 Discharge Characteristics Curves at 25°C

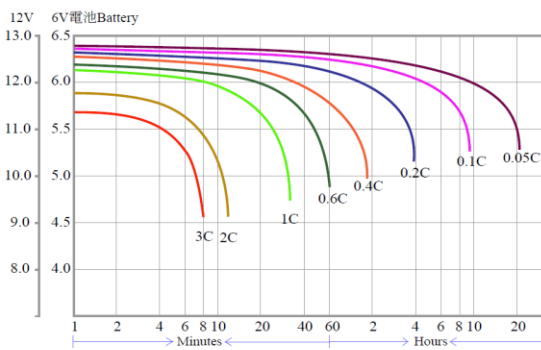

浮充期待壽命 Float Service Life

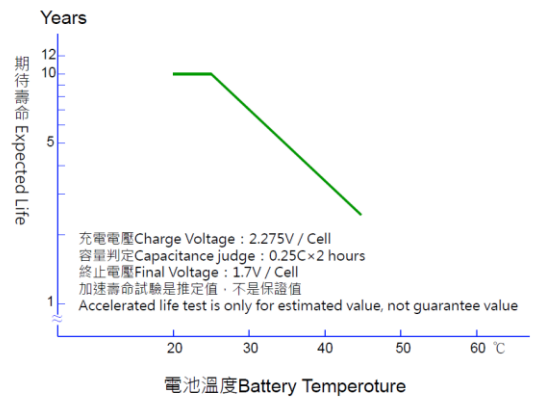

充電特性 CHARGE CHARACTERISTICS

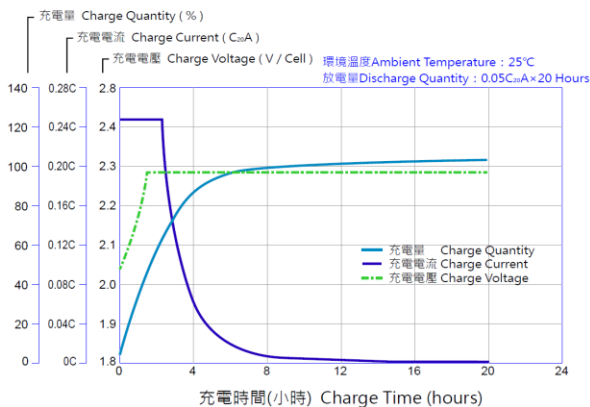

充電電壓 CHARGE VOLTAGE

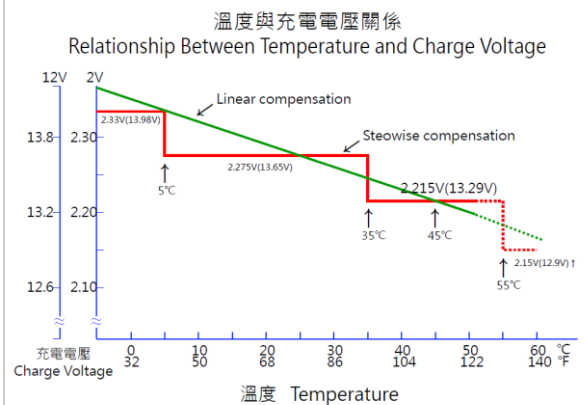

臺灣湯淺電池股份有限公司 新北市新莊區福營路 227 巷 11 號 TEL:(02)2901-8261 FAX:(02)2903-9626
 TAIWAN YUASA BATTERY CO.,LTD No.11, Ln. 227, Fuying Rd., Xinzhuang Dist., New Taipei City <http://www.yuasa.com.tw/>